

Composite dry sliding bushings, metric dimensions

Principal dimensions			Basic load ratings		Mass	Designation
d	D	B	dynamic C	static C0		
mm			kN		kg	-
<b>40</b>	44	30	93	290	0,059	PCM 404430 E

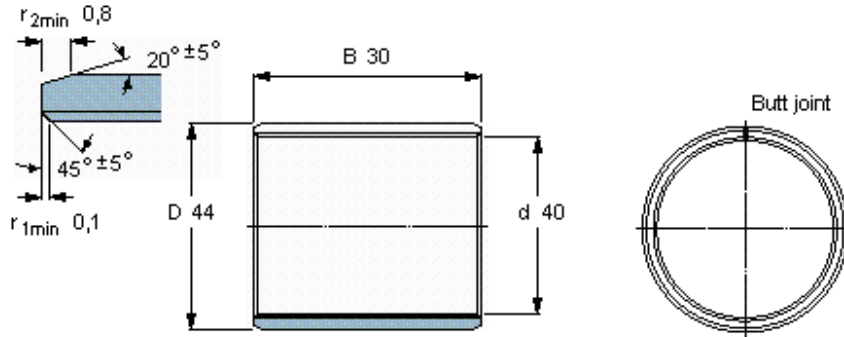

<b>Specific load factor</b>	K 80
<b>Material constant</b>	$K_M$ 480